

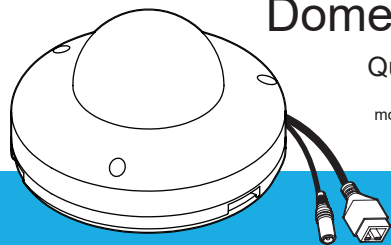

Outdoor Fixed IP Dome Camera

Quick Start Guide

model no: C7012-RW



Please carefully read these instructions before using this product. Save this document for future use.

1. General Specifications

Model No.	C7012-RW
Image Sensor	Sony 1/2.8" CMOS
IP Rating	IP66 (Outdoor)
Wide Dynamic Range	True WDR
Minimum Illumination @ 30 IRE	Color : 2.4 Lux @ F2.0, 30 IRE B/W : 0.5 Lux @ F2.0, 30 IRE
Minimum Illumination @ 50 IRE	Color : 4.0 Lux @ F1.6, 50 IRE B/W : 0.8 Lux @ F1.6, 50 IRE
Day / Night	True Day / Night (IR Cut Filter)
Resolution	1080p (2 MP)
Focal Length	4 mm (86° FoV)
Iris Control	F 2.0
Video Output	H.264 / MJPEG
White Balance	Auto, Manual, Preset
Auto White Balance Range	2000K ~ 11000K
Backlight Compensation	Yes
Auto Gain Control	Yes
Operating Temperature	14°F ~ 122°F (-10°C ~ 50°C)
Power Consumption	4.3W Max
Rated Amperage	360mA
Input Voltage	PoE / 12VDC
Weight	1.0 lb (453.6 g)
Dimensions	(H x W) 2.92" x 4.92" (74.3mm x 125mm)
Housing / Dome Cover	White / Clear

2. Products and Accessories

<p>Camera with Cables</p>	<p>Mount Bolt & Nut - 2 pcs</p>
<p>Torx Wrench</p>	<p>Screw & Plastic Anchor - 3 pcs</p>
<p>Mount Plate</p>	<p>Quick Start Guide</p>
<p>Template Sheet for Installing by Bolt & Nut</p>	<p>Template Sheet for Installing by Plate</p>

3. Product Overview

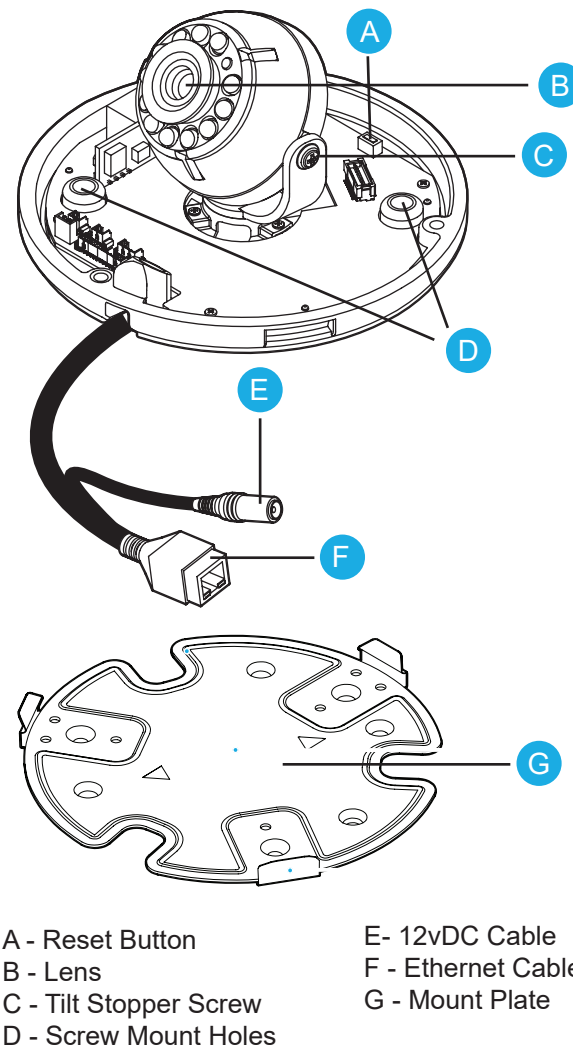

4. Before Installation

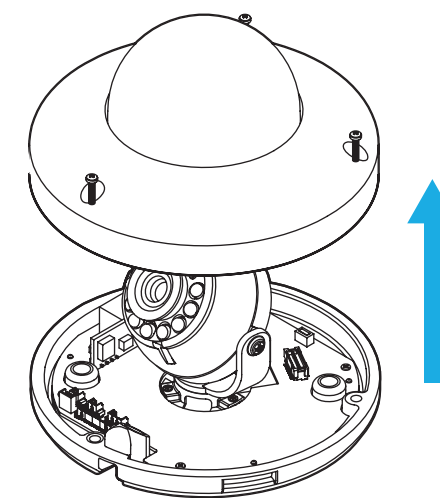

Disassemble the camera:

- Using the Torx wrench, remove the screws from the camera dome cover.
- Lift the dome cover off of the camera base.

5. Lens Orientation

Adjusting the camera position:

- Twist the camera base to the desired position.
- Tilt the camera to the desired position, then tighten the Tilt Stopper Screw to hold the camera in position.

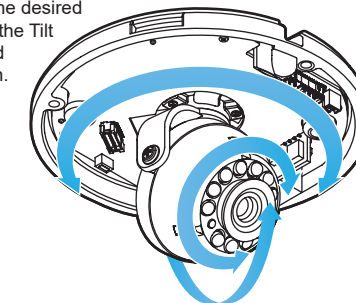

6. Installation Using Screws

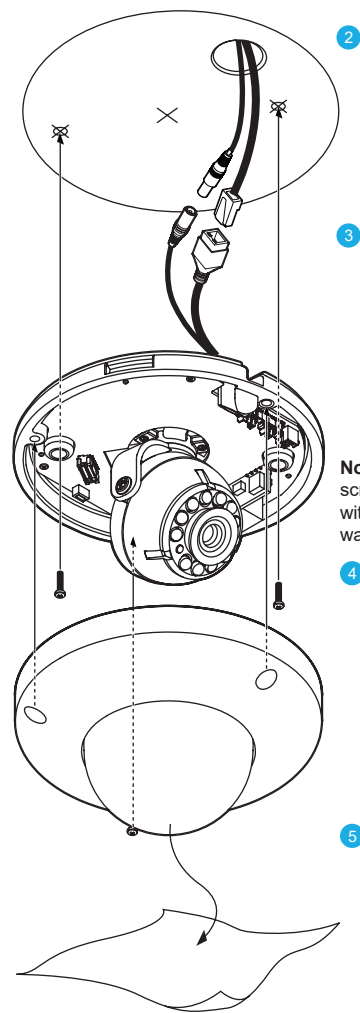

Note: Before tightening screws, prep the screw holes with silicone caulking to ensure water resistance.

- 1 Disassemble the camera. See '4. Before Installation.'
- 2 Using the template sheet provided for installation, make a hole in the ceiling for the cabling.
- 3 Pull the cables through the hole in the ceiling and connect to the camera cables.
- 4 Screw the camera base into the ceiling through the screw mount holes. Before tightening the screws, seal with silicone caulking to ensure water resistance.
- 5 Affix the dome cover to the camera base and remove the protective film from the dome.

7. Installation Using Mount Bolt & Nut or Mount Plate

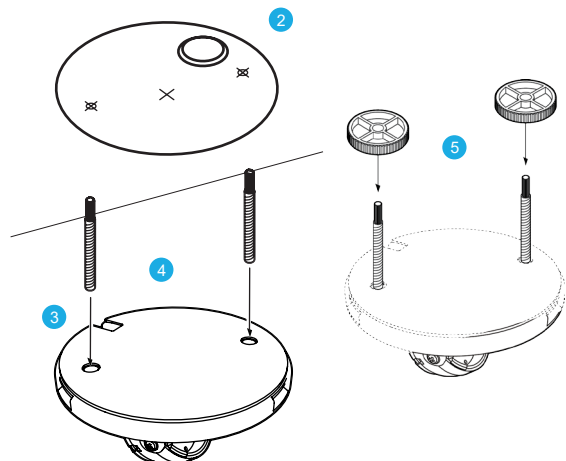

- 1 Disassemble the camera. See '4. Before Installation.'
- 2 Using the template sheet provided for installation, make a hole in the ceiling for the cabling.
- 3 Pull the cables through the hole in the ceiling and connect to the camera cables.
- 4 Screw the mounting bolts into the base of the camera and into the ceiling. Seal mounting bolts to ensure water resistance.
- 5 Screw the nuts onto the bolts and secure tightly. Or see "5A for mount plate installation."
- 6 Affix the dome cover to the camera base and remove the protective film from the dome.

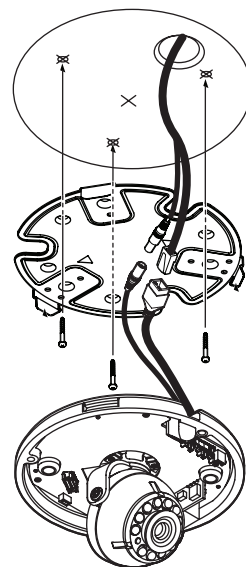

8. MicroSD & Reset

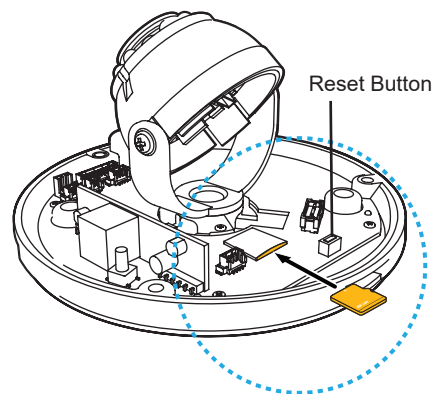

MicroSD Card: a microSD card can be used for emergency back-up. Insert the card as shown. The camera is compatible with up to a 16GB microSD card.

Reset Button: the reset button will return the camera to default factory settings. Press and hold the reset button for 5 seconds to return the camera to factory default settings.

- 4A Using screws, attach the mount plate to the ceiling.
- 5A Attach the camera base to the mount plate by pressing the base into the plate with the bezels and plate hooks aligned until a 'snap' is heard and the camera is secure.
- 6A Ensure mounting screw holes are sealed properly to ensure water resistance.

9. Cabling

This camera is compatible with 12vDC and Power over Ethernet (PoE). Connect power to the camera using the provided power connector lead or connect the camera to a PoE power source. If you are connecting 12vDC power, verify the polarity of the power connection. If you are using PoE, make sure the Power Sourcing Equipment (PSE) is in use in the network.

PoE Power Source:

PoE allows for the transmission of power and data via a single Ethernet cable. PoE eliminates the need for multiple cables to support power and recording. Follow the installation below to connect the camera to a PoE-enabled switch using an Ethernet cable.

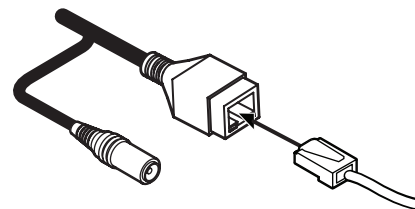

12vDC Power:

If PoE is not being used, a power adapter is needed for power transmission. Follow the instructions below to connect the camera without a PoE cable.

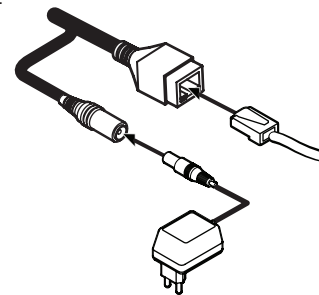

10. Connecting to the IP Camera

To access the camera setup menu, you need to install the AvertX Network Camera Manager on your PC or recorder. To install the AvertX Network Camera Manager application on your PC, download the program from AvertX.com/downloads, and follow the prompts.

1. Open **Network Camera Manager**, and click **Find Devices**.
2. Locate your camera on the **Network Camera Manager** list.
3. To open the viewer software in your web browser, double-click the camera, and then click **Browse**.

The first time you connect to the camera you will automatically be prompted to install the ActiveX controller. If your internet browser doesn't install the viewer software, check the security settings or ActiveX controls and plug-in settings. If your internet browser asks for permission to install the ActiveX control, you must allow the ActiveX control to continue the installation.

To enable installation of ActiveX controls on Internet Explorer:

1. From the **Tools** menu, click **Internet Options**.
2. Click the **Security** tab and then click the **Internet** icon.
3. Click **Custom Level** and ensure that all **ActiveX controls and plug-ins** are set to **Enable** or **Prompt**.

To add the camera to your trusted sites:

1. From the **Tools** menu, click **Internet Options**.
2. Click the **Security** tab and then click **Trusted Sites** icon.
3. Click **Sites**.
4. Type the IP Address of the camera. Ensure that the **Require server verification** check box is unchecked.

For additional information on adjusting the settings of your internet browser, contact your system administrator or refer to the FAQs at AvertX.net.

Default Username and Password

The username and password are case sensitive. It is strongly recommended that the password be changed after the initial setup to prevent unauthorized access.

Username - **admin**

Password - **1234**

11. Assigning an IP Address

AvertX IP cameras are set to get an IP address automatically using DHCP. If a DHCP server like a router is not part of your network, all cameras will have the default IP address 192.168.0.250.

AvertX recommends changing the IP address even if a DHCP server has assigned the camera an address.